

Hardware Synthesis and Dynamic Modeling of Bitumen Tank

AR. Hamed¹, R.R. Darwish¹, E. M. Shaban², and A. M. Abdel ghany³

¹Faculty of Engineering, Helwan University, Egypt.

²Faculty of Engineering, Jazan University, – Saudi Arabia, On leave from Faculty of Engineering (Mataria), Helwan University – Egypt

³Faculty of Engineering, Helwan University. Email: ghanymohamed@ieee.org

Abstract: Bitumen, as one of petrol derivatives, is a raw material used in insulation industries. Bitumen in its raw state needs additives such as polymers and fillers to achieve a certain properties. The mixing temperature depends upon the Bitumen grade and the quantity of additives. The mixing temperature is one of the primary factors considered in the mixing process, which should not exceed $\pm 5\%$ of the specified temperature. The current work accentuates the hardware synthesis of the feedback control system and modelling of the Bitumen tank, sited in INSUMAT Company, Tamouh – Giza, Egypt, <http://www.insumat.com>, in order to achieve the set point of the mixing temperature. The paper shows the interfacing process of the three-way valve to control the flow rate of the hot oil by means of an AC motor and potentiometer, as well as interfacing the PT100 temperature sensor to feedback the current Bitumen temperature to the control system. LabJack UE9 is used as a data acquisition (DAQ) system and signal conditioning unit to interface the whole mechatronics system with a laptop, with preinstalled LabVIEW™ software version 8.0, for the sake of monitoring and controlling. This is followed by Data Based Modelling (DBM) for the entire Bitumen system to estimate its discrete-time Transfer Function (TF) which predicts the dynamic behaviour of the system for the sake of preventive actions. Here, the equation error algorithm is used and compared to well-established Simplified Recursive Instrumental Variable (SRIV) method existed in CAPTAIN toolbox. The results are close enough regarding the TF parameters estimation given the identification of the discrete-time TF. [AR. Hamed, R.R. Darwish, E. M. Shaban, and A. M. Abdel ghany. **Hardware Synthesis and Dynamic Modelling of Bitumen Tank**. *J Am Sci* 2014;10(12):304-310]. (ISSN: 1545-1003). <http://www.jofamericanscience.org>. 39

Keywords: Data Based Modelling (DBM); Discrete-Time Transfer Function (TF), Bitumen tank

1. Introduction

Bitumen is one of the petrol derivatives which used as a mixture in insulation industries, such as roofing materials and other building products. The production of Bitumen mixture is classified as petrochemical industry; it is treated by some additives such as polymers and fillers in its liquid state to achieve the required properties [1, 2]. The produced Bitumen mixture depends mainly upon its grade, the quantity of the additives and the mixing temperature, for example Bitumen 60/70 is called asphaltos whereas Bitumen 100/25 is called oxidize Bitumen, and each has its purpose [3]. The mixing temperature is very important factor which should not exceed $\pm 5\%$ of its specified value [2]. It is required to reach the specified temperature as soon as possible for the sake of productivity, and the temperature should be constant ($\pm 5\%$ of its set value) for the mixing process (the mixer is attached outside the tank) for the sake of quality. It is important to note here that the overshooting in Bitumen temperature is very risky since it is a petrochemical substance and it is possible to reach to self-ignition state, about 200°C.

The heating process of Bitumen in INSUMAT Company is carried out by means of cylindrical tank made from steel surrounded by helical coils filled with hot oil to heat up the raw liquidized Bitumen inside

the tank. The tank is isolated by layers of Rockwool for heat reservation which covered by sheets of galvanized steel, see Fig.1.

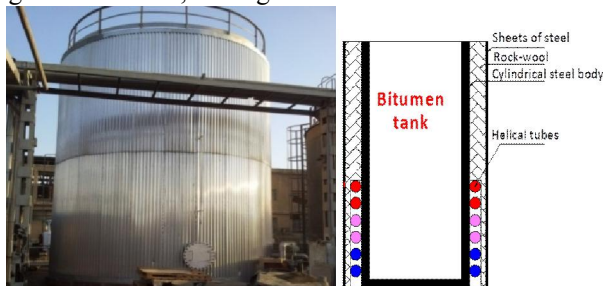

Figure 1. A Bitumen tank existed at INSUMAT Company, Tamouh – Giza, Egypt.

The hot oil is fed from boiler at 265°C via three-way valve, shown in Fig. 2. As shown in this figure, there are three ports. In case of fully opened (100%), all the hot oil from boiler is going into the helical coils of the Bitumen tank, whereas in case of fully closed (0%), all the hot oil from boiler is returned back to the boiler. The flow rate of the hot oil is controlled by means of Proportional-Integral-Derivative (PID) controller, shown in Fig. 3, produced by KFM Company. The action of the PID controller is directed to the AC motor with potentiometer to control the

value of opening of the three-way valve to handle the flow rate of the hot oil. In order to complete the control process for the whole Bitumen system, a PT100 temperature sensor is mounted underneath the tank for feedback process, as depicted in Fig. 4.

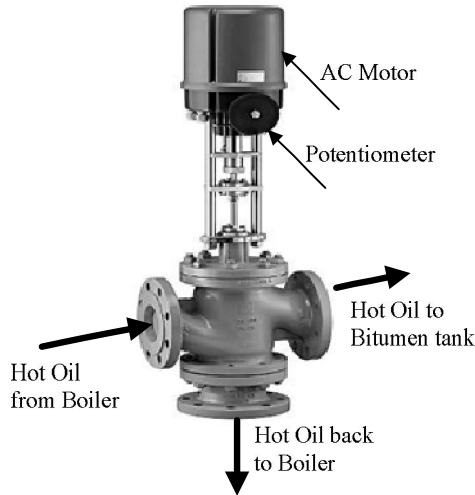

Figure 2. A snapshot of the three-way valve, product number 461405-49f20, www.KFM-Regelungstechnik.de.

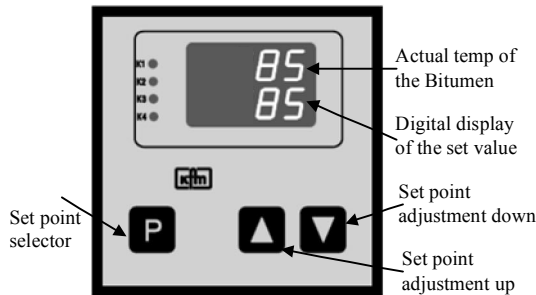

Figure 3. PID controller pad, product number 92702-99hw, www.KFM-Regelungstechnik.de.

The production process of Bitumen mixture is started by feeding the raw liquidized Bitumen from its storage tank at temperature range of 110°C – 120°C into the Bitumen tank, see Fig.4. Here, it is required to keep the temperature of the raw liquidized Bitumen between 110°C to 150°C for the mixing process according to the product and the Bitumen grade [1]. For some Bitumen grades, it is required to keep the temperature of the raw liquidized Bitumen at 180°C. In the other hand, the hot oil is pumped through the helical tubes at temperature of 265°C to heat up the raw liquidized Bitumen to the set point, in about 100 minutes of settling time, and keep the temperature constant or around $\pm 5\%$ of the set temperature for the mixing process. This is the role of the PID controller produced by KFM Company. The PID controller,

shown in Fig. 3, calculates the control action according to the required Bitumen temperature (set point) and the feedback of the current Bitumen temperature inside the tank. As shown in Fig. 4, the control action is then directed to the three-way valve to manipulate the flow rate of the hot oil. The control process is overdamped to avoid overshooting for safety wise.

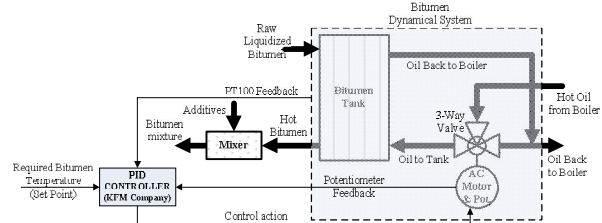

Figure 4. A schematic showing the typical production process of Bitumen at INSUMAT Company.

2. Problem Statement

The Bitumen system has been established in 1994, and gradually over time, the Bitumen tank has been damaged, the Rockwool is crumbled and the sheets of steel wrapping the tank are also broken up and tumbled as shown in Fig. 5. It is worth to report that replacing the tank needs a special concrete basement, which is not practical due to the available area and time consumed. Therefore, reconditioning the tank is essential for both safety and production process. During the renovation process, 1.5 m has been added to the height of the tank to increase its storage capacity by 48 tons, see Fig. 1. The original capacity of the tank is 192 tons; therefore the productivity could be increased by 25%. Also the Diameter of the outlet port for Bitumen is doubled to comprise the new quantity of Bitumen in lesser time.



Figure 5. A snapshot of the worn Bitumen tank, before renovation.

This renewal and amendments processes cause alterations in the dynamic characteristics of the Bitumen tank. Consequently, the production process of Bitumen is malfunctioned due to the steady state

error which always arises between the required temperature of Bitumen (set point) and its current temperature. The PID controller now cannot cope with the new dynamic behaviour of the Bitumen system. Also, tuning process of the PID controller is risky, since the model is not recognized and Bitumen is a petrochemical substance which could be self-ignited if the temperature reaches its flash point, about 200°C. Therefore, an expertise worker is required now in order to keep the temperature around the set point. This manual process gives an unacceptable performance, about $\pm 10\%$ of the set value with about 120 minutes of settling time, see Fig. 6. Accordingly, the mixing process does not meet standards and the Bitumen mixture is out of standards.

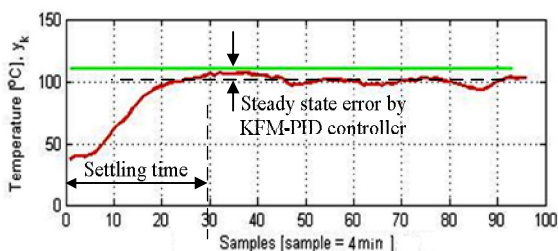

Figure 6. The response of Bitumen system using the KFM-PID controller after renewal, showing the unacceptable performance, February 2014.

This persuades the first author to dynamically analyze the new Bitumen system in order to get a new dynamic model for the tank. This helps in predicting the dynamic behaviour of the system and building a supervisory monitoring system for the production process, this is important for preventive actions. Also the derivation of the Bitumen dynamic model helps tuning the gains for the PID controller or even applying a new controller, this is beyond the scope of the current work. Here, Data Based Modelling (DBM) is carried out to estimate the discrete time, single-input, single output, transfer function (SISO-TF).

3. Setting up of Hardware/Software

This section concerns the replacement of PID controller shown in Fig. 4 with a laptop and signal conditioning unit for interfacing the hardware to the laptop via DAQ unit (LabJack UE9). Also, this section declares the LabVIEW™ program, which created for monitoring, data based modelling, and controlling later on. It is worth to note here that controller design is beyond the scope of this paper.

3.1. Interfacing the three-way valve

The three-way valve, shown in Fig. 2, is used for controlling the flow rate of the hot oil by means of AC motor and potentiometer. The valve is produced by KFM Company with product number 461405-49f20,

www.KFM-Regelungstechnik.de. It is required here to interface both the AC motor and the potentiometer.

It is required for the AC motor (220 VAC/50 Hz) to be driven in both directions for the sake of opening and closing the valve. This can be performed by means of ULN2003A chip, see Fig. 7. As shown in this figure, the chip interfaces the AC motor to the laptop via the LabJack UE9. It is wired from one side to the digital ports of the LabJack UE9, IO1 and IO2, and connected from the other side with two coils of relays R1 and R2 which used to select the direction of the AC motor. Here, the ULN2003A chip is used to amplify the 5 volt from the LabJack UE9 into 24 volt which is required to activate the coils. The figure also shows the setting of the limit switches L1 and L2.

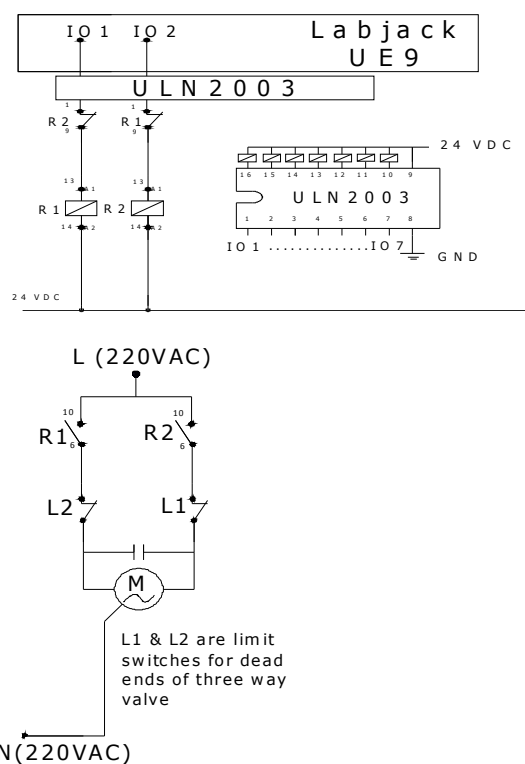

Figure 7. Interfacing the AC motor with LabJack UE9 by means of ULN2003A chip to change the motor rotating direction, the figure shows the setting of limit switches for both dead ends of the valve.

The potentiometer is a resistive element with a wiper that divides the voltage source into two divides according to the position of the wiper. Here, an input voltage of 5 volt is used as a source, and the measured analogue voltage is directly connected to the analogue input of the LabJack UE9, see Fig. 8.

3.2. Interfacing the temperature sensor PT100

The Platinum Resistance Temperature Detector (RTD) is a type of metal, for which its resistance is changed according to temperature change. A typical

resistance of 100 Ω is occurred 0°C, therefore it is called PT100. It is used in industry for many years to measure temperatures up to 850°C. It is characterized by the relatively linear relationship between its resistance and the measured temperature. Since the output signal of PT100 is ohms, a transmitter and a shunt (resistance of 250 Ω), see Fig. 8, are required to convert this signal into useful analogue voltage (1 – 5 volt) which can be recorded by the laptop via analogue port of the LabJack UE9. Here, the transmitter converts the resistance in ohms into current in mA. Typically, 0 – 250°C temperature corresponds to 4 – 20 mA. However, the shunt is used to convert the output current into useful analogue voltage.

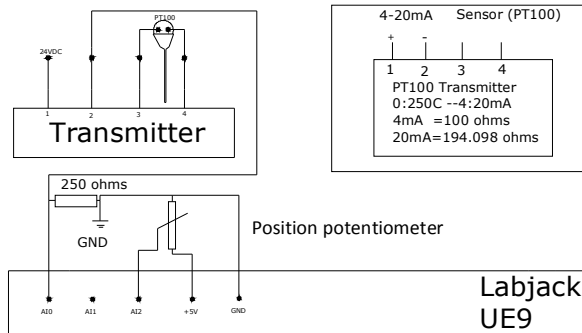

Figure 8. Interfacing the position potentiometer, and PT100 with LabJack UE9 via a transmitter and a shunt of 250 Ω.

3.3. Interfacing with LabVIEW™

The last step for interfacing is creating subVIs which deal with each hardware component (the motored three-way valve and the PT100). Here, visual program is developed for supervisory monitoring of the production process, as well as collecting data for data based modelling for Bitumen dynamic system. This is important for preventive actions and tuning the gains for PID controller or even applying a new controller later on. Fig. 9 shows the front panel of the developed program.

4. Data Based Modelling (DBM)

Experimental or data based modelling is the development of mathematical models of dynamic systems on the basis of measured data from field experiments. The data are utilized to both identify the model structure, i.e. the orders of the polynomials in the TF and the size of the pure time delay, and to estimate the parameters of the discrete-time TF which characterizes the dynamic behaviour of the system.

Sophisticated *time-series* methods are developed for estimating process. Young [4, 5] describes the ordinary recursive instrumental variable (IV) algorithm for determining the parameters that minimizes the error between the TF model and the data collected. However, the simplified refined

instrumental variable (SRIV) employs some pre-filters for parameters estimates with lower standard error, Young [6, 7].

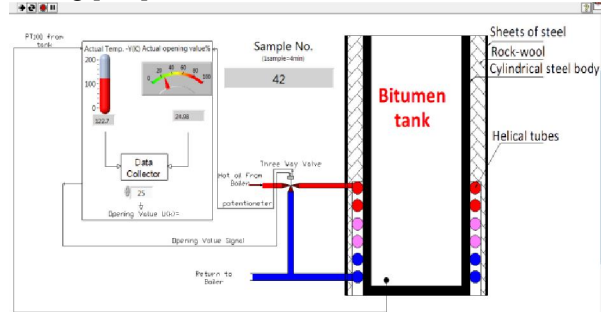

Figure 9. A snapshot of the user interface (front panel) of the LabVIEW program.

4.1. Discrete-time TF

Discrete-time TF plays a crucial role in many applications, such as signal processing, studying the behaviour of dynamic systems, and control theory. Consider the following discrete-time model, in which the sample delay $\delta \geq 1$ is explicitly acknowledged

$$y_k = -\sum_{i=1}^n a_i y_{k-i} + \sum_{i=1}^m b_{i+\delta-1} u_{k-(i+\delta-1)} \quad (1)$$

The TF form of the model (1) can be represented by backward shift operator z^{-1} as

$$y_k = \frac{\sum_{i=1}^m b_{i+\delta-1} z^{-(i+\delta-1)}}{\sum_{i=1}^n a_i z^{-i}} u_k = \frac{B(z^{-1})}{A(z^{-1})} u_k \quad (2)$$

for which n is the number of output parameters $\{a_1, \dots, a_n\}$, and m is the number of input parameters $\{b_\delta, \dots, b_{m+\delta-1}\}$. As depicted in model (2), any pure time delay of $\delta > 1$ samples can be accounted by setting the $\delta-1$ leading parameters of the $B(z^{-1})$ polynomial to zero, i.e. $b_1, \dots, b_{\delta-1} = 0$.

4.2. Model identification and estimation

It is very important to identify the structure of the appropriate model (2) that best describes the given dynamical system, i.e. the most appropriate values for the triad $\{n, m, \delta\}$. There are two main statistical measures employed to help determine the most suitable model structure. The first is the coefficient of

determination R_T^2 which based on the model errors,

$$R_T^2 = 1 - \frac{\sum_{k=1}^N e_k^2}{\sum_{k=1}^N y_k^2} \quad (3)$$

where e_k represents the model error, y_k is the measured output and \hat{y}_k is the model response (1). Here, N represents the number of data points. As seen from the previous equation, this measure evaluates how well the model fits the data – the closer to unity, the better the fit. The other statistical measure is the more sophisticated Young Identification Criterion (YIC), which provides a combined measure of model fit and parametric efficiency, i.e. the TF is not over-parameterized [6, 7]. The large negative value for YIC indicates a model that explains the output well without over-parameterization. All these statistical tools and associated algorithms have been assembled as CAPTAIN toolbox within the Matlab® environment (www.es.lancs.ac.uk/cres/captain) [8].

4.3. Equation error method for model estimation

Consider the model response of TF model (1) to be \hat{y}_k . In order to estimate the model parameters $a_1, \dots, a_n, b_\delta, \dots,$ and $b_{m+\delta-1}$, the measurement for the actual system output y_k should be carried out. Therefore, the cost function is

$$J = \sum_{k=1}^N e_k^2 \tag{4}$$

The most obvious way of estimating TF parameters, implicated in (4), is shown in Fig. 10. Here, a cost function J is defined as the sum of the squares of the response error, e_k , where $e_k = y_k - \hat{y}_k$. There are several approaches to solve this problem; one of them is the equation error method.

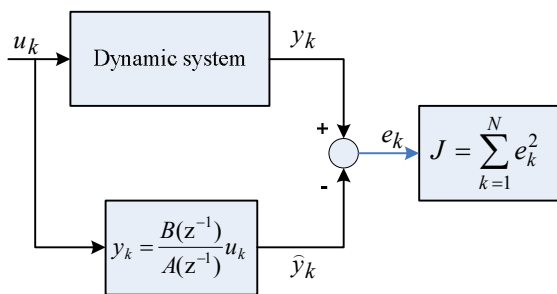

Figure 10. The general approach for estimating TF model (1).

The cost function (4) can be written as

$$J = \sum_{k=1}^N \left(y_k + \sum_{i=1}^n a_i y_{k-i} - \sum_{i=1}^m b_{i+\delta-1} u_{k-(i+\delta-1)} \right)^2 \tag{5}$$

Applying $n + m$ partial differentiation with respect to the parameters $\{a_1, \dots, a_n, b_\delta, \dots,$ and

$b_{m+\delta-1}\}$, the following system of simultaneous equations of the unknowns $a_1, \dots, a_n, b_\delta, \dots,$ and $b_{m+\delta-1}$ arises,

$$\begin{aligned} \frac{\partial J}{\partial a_i} &= 2 \sum_{k=1}^N \left(y_k + \sum_{i=1}^n a_i y_{k-i} \right) y_{k-i} \\ &\quad - 2 \sum_{k=1}^N \left(\sum_{i=1}^m b_{i+\delta-1} u_{k-(i+\delta-1)} \right) y_{k-i} \\ &= 0 \quad (i = 1, \dots, n) \end{aligned}$$

$$\begin{aligned} \frac{\partial J}{\partial b_{i+\delta-1}} &= -2 \sum_{k=1}^N \left(y_k + \sum_{i=1}^n a_i y_{k-i} \right) u_{k-(i+\delta-1)} \\ &\quad + 2 \sum_{k=1}^N \left(\sum_{i=1}^m b_{i+\delta-1} u_{k-(i+\delta-1)} \right) u_{k-(i+\delta-1)} \\ &= 0 \quad (i = 1, \dots, m) \end{aligned} \tag{6}$$

The system of simultaneous equations (6) can be rewritten in matrix form as $Ax = B$, for which

$$\begin{aligned} A &= \begin{bmatrix} \left[\sum_{k=1}^N y_{k-i} y_{k-j} \right] & - \left[\sum_{k=1}^N y_{k-i} u_{k-(j+\delta-1)} \right] \\ \vdots & \vdots \\ \left[\sum_{k=1}^N u_{k-(i+\delta-1)} y_{k-j} \right] & \left[\sum_{k=1}^N u_{k-(i+\delta-1)} u_{k-(j+\delta-1)} \right] \\ \vdots & \vdots \\ \left[\sum_{k=1}^N y_k y_{k-i} \right] & \\ \vdots & \\ \left[\sum_{k=1}^N y_k u_{k-(i+\delta-1)} \right] & \\ \vdots & \\ \left[\sum_{k=1}^N u_k u_{k-(i+\delta-1)} \right] & \end{bmatrix} \\ B &= \begin{bmatrix} \left[\sum_{k=1}^N y_k y_{k-i} \right] \\ \vdots \\ \left[\sum_{k=1}^N y_k u_{k-(i+\delta-1)} \right] \\ \vdots \\ \left[\sum_{k=1}^N u_k u_{k-(i+\delta-1)} \right] \end{bmatrix} \\ x &= [a_1 \quad \dots \quad a_n \quad b_\delta \quad \dots \quad b_{m+\delta-1}]^T \end{aligned} \tag{7}$$

5. Deriving TF model for the Bitumen System

The system of equations (7) represents equation error method for deriving any discrete-time TF of dynamical system. The algorithm is programmed using Matlab®. Initially, the program asks for the name and path of the data file, then requests the identification of the TF, i.e. the triad $\{n, m, \delta\}$. According to the data file and the TF identification, the program calculates and reveals the TF parameters with coefficient of determination, R_T^2 , to show the efficiency of the TF. Also, a plot for the data collected and the response of the TF model is appeared.

The TF for the Bitumen system takes the form of (2), for which y_k is the Bitumen temperature and u_k is the opening of the three-way valve, expressed as a percentage in the range 0 to 100 corresponding to fully closed to fully open respectively. This normalizing process for the input term, u_k , is very important for the TF estimation process.

Since the rate of change of the input is 70/min and the Bitumen system shows, relatively, slow dynamics behaviour, the sampling rate has been selected to be 1 sample every 4 minutes.

In order to identify the dominant dynamics of the Bitumen tank, a number of open-loop experiments are conducted for a range of applied valve openings, all the data files are based on sampling rate of 1 sample every 4 minutes. Several experiments show that this sampling rate provides good compromise between good-enough response and a desirable low order TF model. In the case of Bitumen system, a first order model, with one numerator parameter of 3 samples time delay provides the best explanation of the data collected, i.e.

$$y_k = \frac{b_3 z^{-3}}{1 + a_1 z^{-1}} u_k \tag{8}$$

recalling that y_k is the Bitumen temperature and u_k is the opening percentage of the three-way valve.

The algorithm of equation error method are implemented at four different data files; they are pulse input at full load, step input at both half and full load, and random input, for which half and full load represent 50% and 100% of the three-way valve opening respectively. Figs. 11, 12, 13 and 14 shows the data collected and corresponding TF response.

As shown in Figs. 11, 12, 13, and 14, each type of excitation gives its own TF parameters. Here, the random input is selected as a reference for averaging the TF parameters.

For verification, the SRIV algorithm [6, 7] combined with the YIC and R_T^2 identification criteria discussed in Section 4.2 has been implemented using CAPTAIN toolbox in Matlab® software [8]. The algorithm reveals the same TF triad $\{1, 1, 3\}$ with close estimates for the TF parameters. Fig. 15 shows a comparison between the two models estimated using both equation error and SRIV algorithms when applied to the random data file.

It is obvious from Fig. 15 that SRIV algorithm enhances the model responses. The TF parameters given $\{a_1 = -0.9721$ and $b_3 = 0.06964\}$ shows better model fitting to the data given.

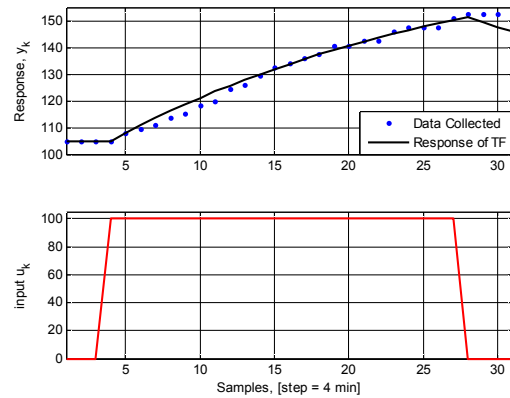

Figure 11. The response of the model (8), with respect to data collected at pulse input (100%), using equation error method. The model parameters are $a_1 = -0.9594$ and $b_3 = 0.0299$ at $R_T^2 = 0.9859$.

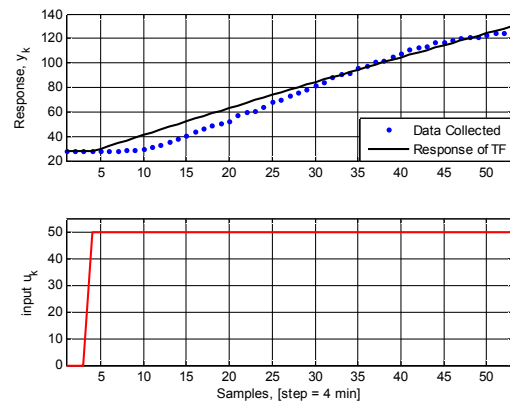

Figure 12. The response of the model (8), with respect to data collected at step input (50%), using equation error method. The model parameters are $a_1 = -0.9963$ and $b_3 = 0.0456$ at $R_T^2 = 0.9775$.

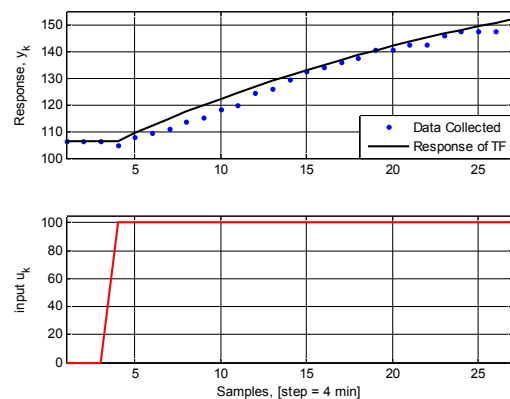

Figure 13. The response of the model (8), with respect to data collected at step input (100%), using equation error method. The model parameters are

$$a_1 = -0.9642 \quad \text{and} \quad b_3 = 0.0288 \quad \text{at} \quad R_T^2 = 0.9916$$

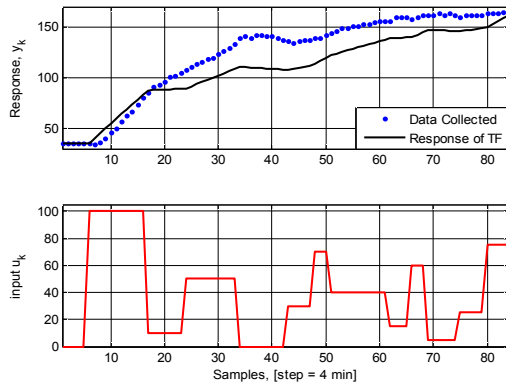

Figure 14. The response of the model (8), with respect to data collected at random input, using equation error method. The model parameters are $a_1 = -0.9642$ and $b_3 = 0.0482$ at $R_T^2 = 0.9244$.

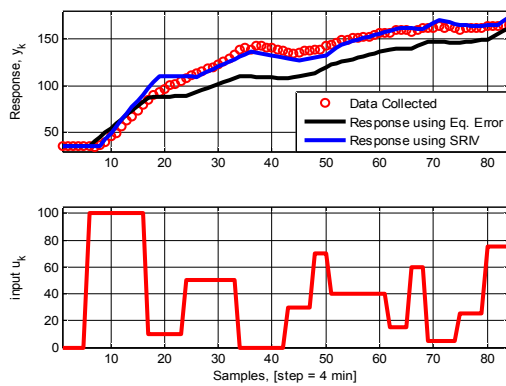

Figure 15. The response of the model (8), with respect to data collected at random input, using equation error method [solid] and SRIV algorithm [dashed]. Equation error method gives $a_1 = -0.9642$ and $b_3 = 0.0482$ at $R_T^2 = 0.9244$, whereas SRIV algorithm gives $a_1 = -0.9721$ and $b_3 = 0.06964$ at $R_T^2 = 0.9789$.

6. Conclusions

This paper shows the practical development of Bitumen dynamic system at INSUMAT Company. The Bitumen tank has been impaired over time. At this point, renovation of Bitumen tank is a must. During renovation process, enlargement of the tank height and doubling the diameter of the outlet port take place for productivity. To certain extent, these modifications

alter the dynamic behaviour of the system and the KFM-PID controller with its current constants does not cope with the Bitumen system and this affects the produced Bitumen quality. It is worth to note here that re-tuning the PID controller is very risky, since overshooting is undesirable to avoid Bitumen self-ignition, if it reaches its flash point.

The current work develops a new dynamic model using data based modelling. Both equation error method and SRIV algorithm are used and compared to get the dynamic model that best describes the dynamic behaviour of the Bitumen system. The SRIV algorithm shows better modelling for the system, see Fig. 15.

The new dynamic model helps in predicting the dynamic behaviour of the system, so a supervisory monitoring system using LabVIEW™ is built for the production process and preventive actions.

Now it is possible to tune the gains of the PID controller with the aid of the developed model or even apply a new control system. This is beyond the scope of this work and will be investigated by the authors and reported in future publications.

Acknowledgment

The authors are grateful for the support of Eng. Ahmed Osman Ahmed Osman, INSUMAT Company.

References

1. Forth J. P.; S. E. Zoorob; I. N. A. Thanaya "Development of bitumen-bound waste aggregate building blocks" Proceedings of the ICE – Construction Materials, Vol. 159, Issue 1, pp. 23–32, February 2006.
2. ASTM D6222 / D6222M-11, Standard Specification for Atactic Polypropylene (APP) Modified Bituminous Sheet Materials Using Polyester Reinforcements, ASTM International, West Conshohocken, PA, 2011, www.astm.org.
3. Read, John; Whiteoak, David "The shell Bitumen Handbook, fifth edition" Copyright Date 2003.
4. Young P.C., Recursive Estimation and Time Series Analysis, Springer-Verlag, Berlin, 1984.
5. Young P.C., The instrumental Variable Method: A Practical Approach to Identification and System Parameter Estimation, Appears in H.A. Barker and P.C. Young (ed.), Identification and System Parameter Estimation, Pergamon, Oxford, Vols.1 and 2, pp.1–16, 1985.
6. Young P.C., "Simplified Refined Instrumental Variable (SRIV) Estimation and True Digital Control (TDC)", *1st European Control Conference*, pp.1295–1306 (Grenoble), 1991.
7. Young P.C., "Data-Based Mechanistic Modelling of Engineering Systems", *Journal of Vibration and Control*, Vol.4, pp.5–28, 1998.
8. Pedregal D.J., C.J. Taylor, and P.C. Young. System Identification, Time Series Analysis and Forecasting. The Captain Toolbox. Handbook v2.0, February 2007.